

C1300 Advanced Circular Chart Recorder

C1300 – dependable recording
in a rugged, functional
instrument



High-definition backlit display

- latest LCD panel display technology ensures instrument operation and configuration is as easy as possible

Simple-to-configure totalizers

- automatic calculation of the relationship between units of measure and volume flow units

Designed to survive

- environmental protection options up to NEMA 4X for the entire recorder, providing reliable operation for wall-, panel- and pipe-mount versions

Data logging

- logging of totalizer and instantaneous readings to a Compact Flash card

Fully field-upgradeable

- additional options easy to add

Configuration backup

- ability to backup and restore configurations from a PC

C1300

The C1300 is an advanced, programmable circular chart recorder for up to four process signals. It combines traditional circular chart values with data logging technology from ABB's award-winning SM Series videographic recorders to create a labour-saving recording solution. The C1300's straightforward operator controls and robust construction make it suitable for a variety of industrial environments. With many features supplied as standard and a powerful range of options, the C1300 is a truly flexible unit that can adapt to match your process requirements.

Comprehensive Process Information

The C1300 incorporates up to two graphical display panels to keep the operator informed of process status. Each panel is capable of displaying up to eight lines of descriptive text to simplify both configuration and operation of the recorder. The display technology used increases visibility in high ambient light conditions.

Simple Operation

The clearly-labelled tactile keypad gives direct access for operator adjustments and configuration, without the need to open the recorder's door. Clear text prompts on the digital displays guide the user through the various menus. A password-protected security system prevents unauthorized access to configuration adjustment menus.

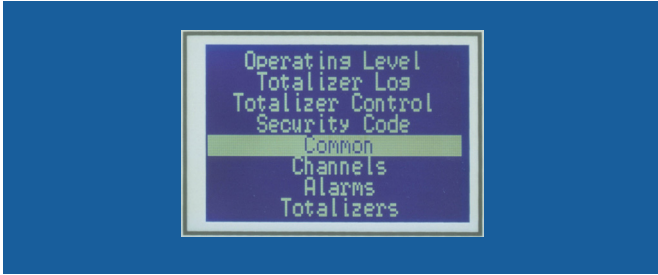

Clear, Intuitive Display Menus

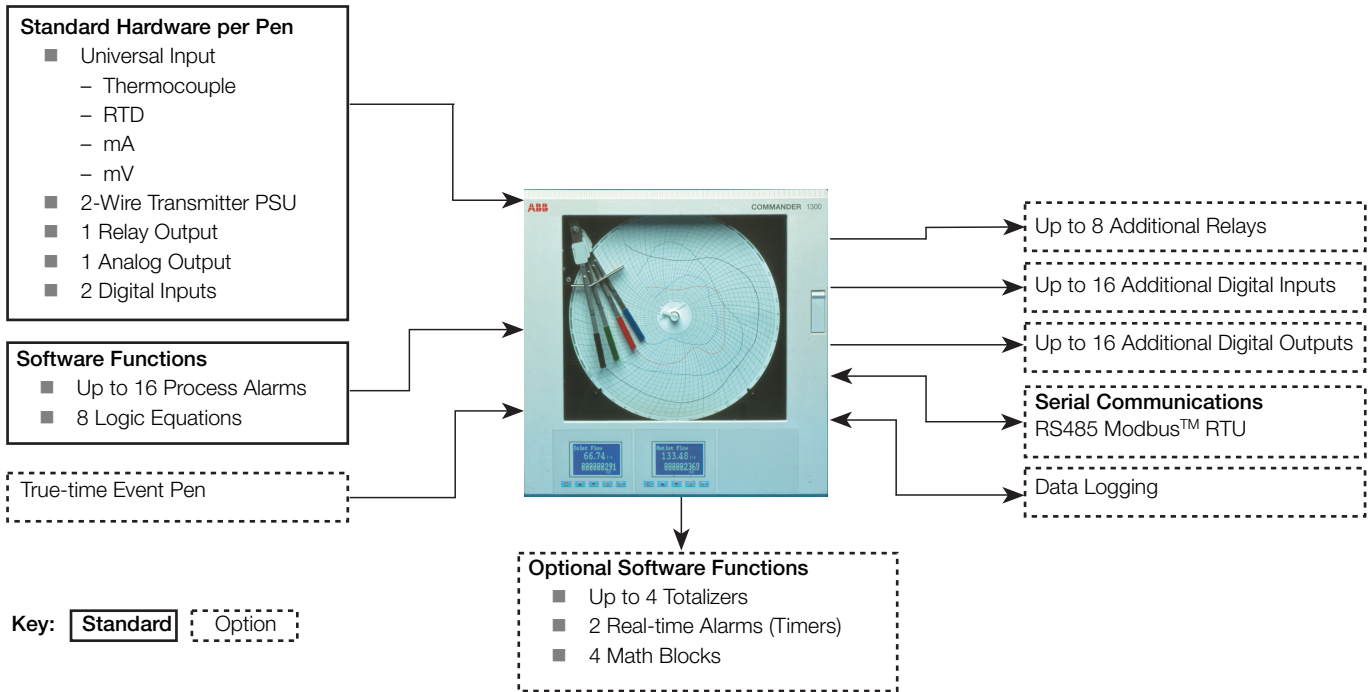

C1300

Advanced Circular Chart Recorder

Advanced Totalizer Technology

The C1300 features some of the most advanced totalizing features of any recording instrument, giving it the ability to autoconfigure totalizers to specific requirements. For example, it is possible to measure flow in one volumetric unit and totalize in another; the C1300 automatically calculates the relationship between the two volume units and configures this information. No longer is it necessary to deal with unit conversion tables and timebases.

Totalizer control is enhanced further by reset functionality that is set in real-time. If the totalizer is required to reset at midnight every Sunday simply set it to do so. Totalizer logs also eliminate the requirement for the operator to go to the recorder at the same time each day to take readings. The totalizer log contains historical information of the date, time and individual totalizer values; enabling comparison of process volumes directly from the front panel of the recorder.

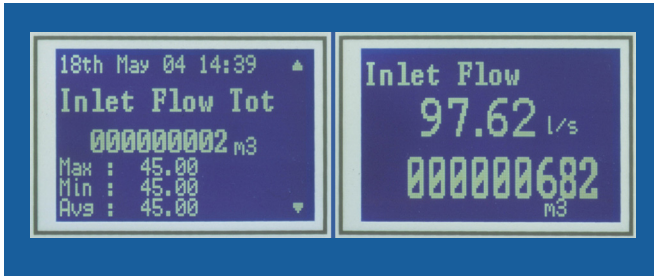

Comprehensive Flow Totalizer Displays

PC Configuration Backup

Fitted as standard to every C1300 is a PC Configuration Backup port. Using this port, an instrument's configuration can be both uploaded and downloaded to a PC, enabling a backup of a recorder's configuration to be saved for future use. Configuration time of multiple units with similar configurations is also greatly reduced via use of this feature.

Timers and Clock

The C1300 provides two event timers driven by the recorder's real-time clock. The timers can be configured to operate relays, start/stop the chart or trigger other actions within the recorder; such as allowing alarm annunciation only during night hours.

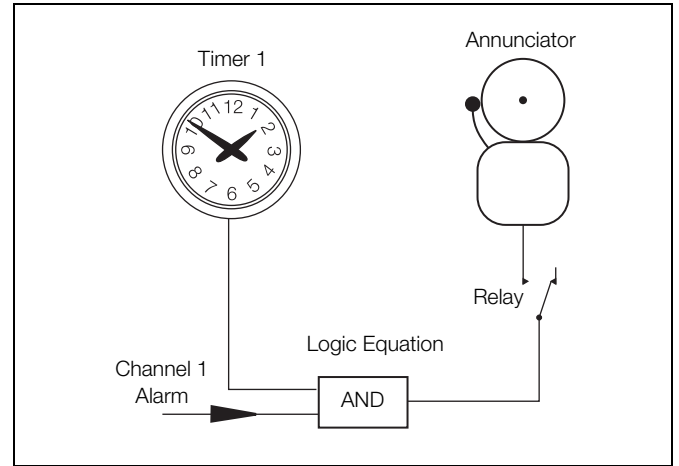

Alarm Annunciation Enabled During Night Hours Only

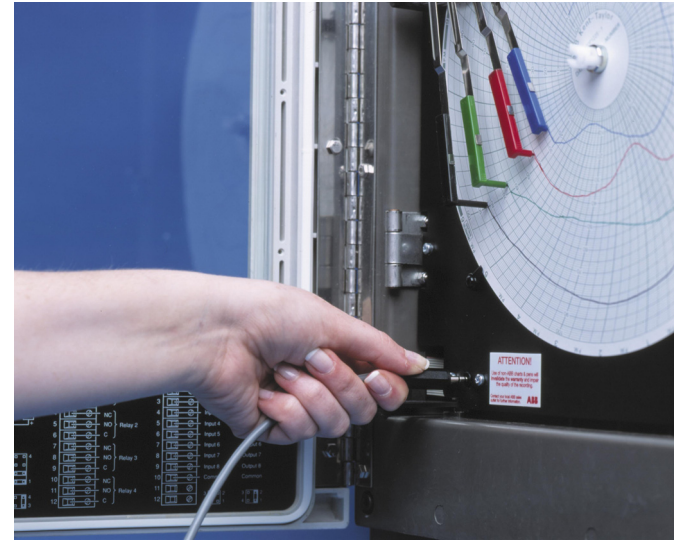

Connecting Your PC to the Recorder

Math and Logic

Optional math functions, mass flow calculations and RH tables are available, enabling the solving of real process problems, quickly and simply. Math functions include addition, subtraction, multiplication and division.

Logic capability is provided as standard, for interlocking and integration of discrete and continuous functions to address a wide range of process criteria.

Boolean logic functions enable the grouping of alarms to a single 'common-trouble' relay, saving time and money or allowing interlocking to create almost infinite combinations of 'If...Then' scenarios.

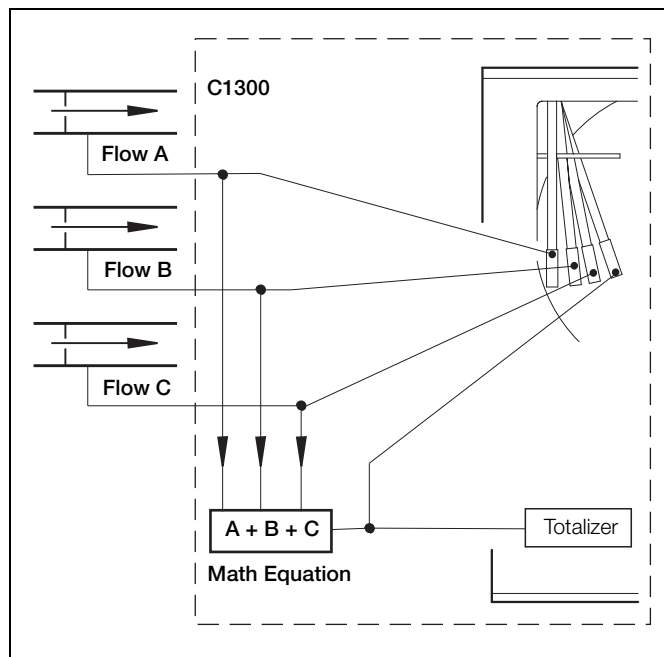

Summation of Three Flows

Built to Meet Your Needs

The C1300's modular architecture enables a high level of hardware choice.

The standard input/output module supplied with every pen comes complete with a fully isolated universal analog input, a relay output, transmitter power supply, an isolated analog output and two digital inputs.

Further input and output capability is provided by a range of plug-in modules:

- Four relays – channel alarm outputs
- Eight digital inputs – linked using logic equations
- Eight digital outputs – TTL level alarm outputs
- True-time event pen (Violet) – event pen is additional to standard pens
- Modbus RS485 communications – interfaces with PCs
- Data logging – to Compact Flash card

Expandable for the Future

The C1300 can be upgraded quickly to meet your changing process requirements.

Additional recording channels, math capability or input and output functions can be retrofitted on-site using plug-in modules and easily-fitted pen arms. Input calibration data is stored on each card, enabling quick changes of input modules without the need for recalibration.

Changes to input sensors or recording requirements are accommodated by reconfiguration using the keypad.

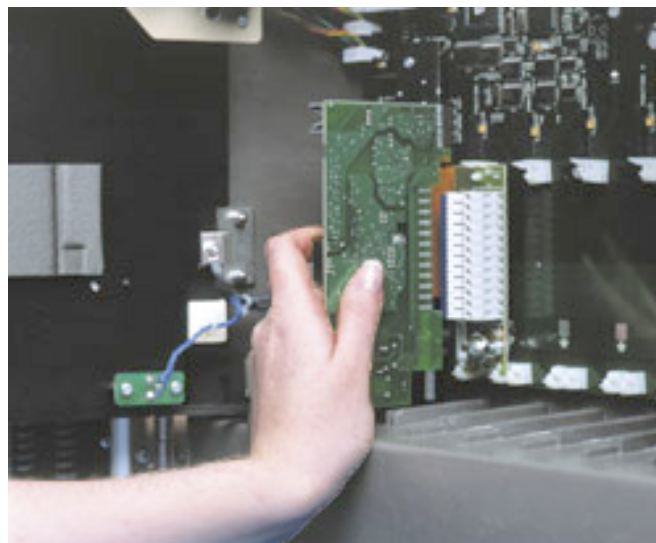

Modular Design Enables Unit to be Upgraded Quickly

Modbus RS485 Communications

Communications with PCs or PLCs are achieved via the RS485 serial communications link, enabling the C1300 to serve as the front end of plant-wide data acquisition systems. Using Modbus RTU protocol all process inputs and other variables can be read continuously by a host PC running any of a wide range of standard SCADA packages.

C1300

Advanced Circular Chart Recorder

4-Pen Recording

Available with up to four trending pens, the C1300 enables pen ranges to be configured independently from each other and their corresponding inputs. This enables the pens to be scaled to the best effect and potentially minimizes the requirement for costly multiple-scaled consumables. The C1300 also offers a true-time event-pen facility that ensures that process actions are logged on the same timeline as Pen 1.



4-pen Recorder with Two Graphical Display Panels

Data Logging

The C1300 can be fitted with a data logging option that automatically stores the totalizer log entries and instantaneous channel data to a Compact Flash card. Once logged to a card, ABB's DataManager software can be used to analyze the totalizer log and create graphs of the instantaneous data.

Simple operation is ensured due to the automatic initiation of logging upon the insertion of a Compact Flash card and extremely simple card removal procedure.

As a result of the large capacity of Compact Flash cards, exceptionally long recording durations can be achieved which minimizes the requirement for operator intervention to retrieve data.

The Compact Flash card is located behind the door of the recorder and can be protected by the optional door lock.



Removing Compact Flash Card

Designed to Survive

Optional NEMA 4X protection ensures the C1300 can survive in the harshest environments and makes the recorder ideal for use in panels that are hosed down regularly. The tough, acid-resistant case provides NEMA 4X rating for all mounting options.

Easy to Install

A choice of mounting options enables simple installation of the recorder in a panel, on a wall or on a pipe. Detachable terminal blocks provide trouble-free connection of input and output wiring. Mains isolation can be provided by an optional power switch within the instrument.

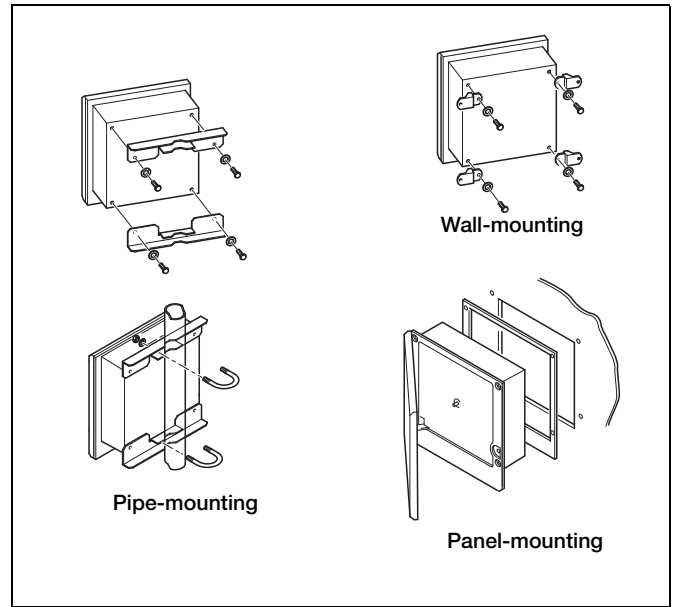

Choice of Mounting Options

Summary

1, 2, 3 or 4 pens

10 in. or 105mm chart size

Standard I/O with each pen includes:

analog input, analog output, transmitter power supply, relay output and 2 digital inputs

Specification

Construction

Size	15.23 in. (h) x 15.04 in. (w) x 5.57 in. (d) (386.8 x 382.0 x 135mm)
Weight	18lb (8.2kg)
Case material	Glass fiber-filled reinforced polyester
Window material	Polycarbonate or glass
Door latch	High-compression with optional lock

Environmental

Operational temperature range	0° to 55°C (32° to 130°F)
Operational humidity range	5 to 95%RH (non-condensing) 5 to 80%RH (chart only)
Case sealing	NEMA 3 (IP54) NEMA 4X (IP66) (optional)

Installation

Mounting options	Panel, wall or pipe
Terminal type	Screw
Wire size (max)	14 AWG (I/O), 12 AWG (power)

Operation and Configuration

Programming method	Via front panel keys
Security	Password-protected menus

Safety

General safety	EN61010
Installation category	II
Pollution degree	2
Dielectric	500V DC (channel/channel) 2kV DC (channel/ground)
Memory protection	Nonvolatile FRAM
Approvals	CE CSA General Safety (option) UL General Safety (option)

Power Supply

Voltage	100 to 240V AC \pm 10% (90V min. to 264V AC max.), 50/60Hz
Consumption	<30 VA (typical for full spec. unit)
Line interruption	Up to 60ms

Process Inputs and Outputs

General

Noise Rejection	Common mode >120dB at 50/60Hz Normal (series) mode >60dB at 50/60Hz
CJC rejection ratio	<0.05°C/°C (0.1°F/°F)
Sensor break protection	Upscale or downscale drive
Out of range detection	0 to 100% of engineering span
Temperature stability	<0.02% of reading/°C (0.04% of reading/°F) or 1 μ V/°C
Long-term drift	<0.01% of reading or 10 μ V annually
Input impedance	>10MW (mV and V inputs) 39W (mA input)

Analog Inputs

Signal types	mV, V, mA, W
Thermocouple types	B, E, J, K, N, R, S, T
Resistance thermometer	Pt 100
Other linearizations	$x^{1/2}$, $x^{3/2}$, $x^{5/2}$, linear
Sample interval	250ms per channel
Dielectric	500V DC channel/channel
Digital Filter	0 to 60s (programmable)

Type	Range Low	Range High	Minimum Span	Accuracy
mV	0	150	5	\pm 0.1% reading or 10 μ V
V	0	5	0.1	\pm 0.1% reading or 20mV
mA	0	50	1	\pm 0.2% reading or 0.2 μ A
Ohms (low)	0	750	20	\pm 0.2% reading or 0.1W
Ohms (high)	0	10k	400	\pm 0.5% reading or 10 Ω

Analog Input Performance

C1300

Advanced Circular Chart Recorder

Type	°C		°F		Accuracy (excluding CJC)
	Range Low	Range High	Range Low	Range High	
B	-18	1800	0	3270	±2.0°C (above 200°C) (3.6°F [above 434°F])
E	-100	900	-140	1650	±0.5°C (0.9°F)
J	-100	900	-140	1650	±0.5°C (0.9°F)
K	-100	1300	-140	2350	±0.5°C (0.9°F)
N	-200	1300	-325	2350	±0.5°C (0.9°F)
R	-18	1700	0	3000	±1.0°C (above 300°) (1.8°F [above 572°F])
S	-18	1700	0	3000	±1.0°C (above 200°C) (1.8°F [above 434°F])
T	-250	300	-400	550	±0.5°C (0.9°F)
PT100	-200	600	-325	1100	±0.5°C (0.9°F)

Thermocouple Performance

2-Wire Transmitter Power Supplies

Number	1 per channel
Voltage	24V DC nominal
Drive	Up to 25mA
Isolation	500V DC channel-to-channel

Digital Outputs

Type	5V TTL
Rating	5mA per output
Dielectric	500V DC between modules, no isolation within module

Analog Outputs

Type	4 to 20mA
Accuracy	±0.1%
Maximum load	750W
Dielectric	500V DC

Serial Communications

Connections	RS485, 4-wire
Protocol	Modbus RTU

Data Logging

Memory card type	Compact Flash Type 1
Card size	Max. 1Gb
Recording Duration	See table below

Relay Outputs

Type	SPDT
Rating (with non-inductive load)	5A at 115/230V AC

Digital Inputs

Type	TTL or volt-free
Minimum pulse	250ms
Dielectric	500V DC between modules, no isolation within module

(4 Channels)	128Mb	256Mb	512Mb	1Gb
1 s	1.1 months	2.3 months	4.5 months	8.8 months
5 s	5.6 months	11.3 months	1.9 years	3.6 years
10 s	11.3 months	1.9 years	3.7 years	7.2 years
30 s	2.8 years	5.6 years	11.1 years	21.7 years
60 s	5.6 years	11.1 years	22.2 years	43.4 years
5 min.	27.8 years	55.5 years	111.0 years	216.8 years
10 min.	55.5 years	111.0 years	222.1 years	433.7 years
30 min.	166.5 years	333.1 years	666.2 years	1301.1 years
1 hour	333.1 years	666.2 years	1332.3 years	2602.2 years
6 hour	1998.5 years	3996.9 years	7993.9 years	15613.1 years

Recording Duration

C1300
Advanced Circular Chart Recorder

Recording System

Pens

Number	1, 2, 3, or 4 (red, green, blue, black)
Response	7 seconds (full scale)
Resolution	0.1% steps
Pen lift	Motor-driven, with optional autodrop

Event Pens

Standard	3-position event recording on any channel
Real time	3-position event recording on the same time line as Pen 1

Chart

Chart size	10 in. or 105mm
Chart speed	1 to 167 hours or 7 to 32 days per revolution
Rotation accuracy	<0.5% of rotation time

Graphical Display Panels

Displays

Number	1 (1 or 2 pens) or 2 (3 or 4 pens)
Type	High contrast 128 x 64 STN dot matrix LCD (graphics) module
Status indicators	Indicate channel number on display
Alarm indicators	Indicate channel with active alarms

Panel keys

Function	Programming access, increment/decrement, pen lift and menu key
----------	--

Alarms and Logic

Alarms

Number	4 per channel
Type	High/low process, fast/slow rate of change, time delay
Adjustments	Hysteresis, time delay
Alarm indicators	Indicate channel with active alarms

Logic Equations

Number	4
Function	OR, AND
Inputs	Alarm states, digital inputs, totalizers, logic
Outputs	Relays, digital outputs, chart stop, alarm acknowledge

Advanced Software Functions

Totalizers

Number	Up to 4
Size	999,999,999 max.
Output	External counter driver, 'wrap' pulse signal
Totalizer log	Max. 21 entries per totalizer

Math

Number of equations	4
Type	+, -, x, ÷, low & high select, maximum, minimum, average, mass flow, RH

Timers

Number	2
Type	Real-time clock driven event, adjustable duration
Output	Relay, digital output, logic equation

EMC

Emissions and Immunity

Meets requirements of:
 EN50081-2
 EN50082-2
 EN61326 for an industrial environment
 CE Mark

Module Type	I/O Per Module							Max. No. Per Instrument
	Analog I/P	Analog O/P	Trans. PSU	Relays	Digital I/P	Digital O/P	Comms.	
Standard I/O	1	1	1	1	2			4
4 relays				4				2
8 digital I/P					8			3
8 digital O/P						8		3
RS485 comms.							1	1

Option Module Types

Electrical Connections

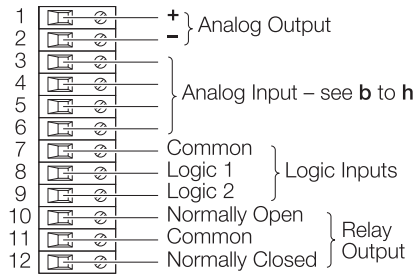

Summary of Connections

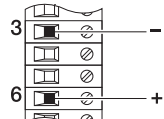

b – Voltage

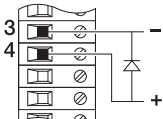

**c – Current
(non 2-wire Transmitters)**

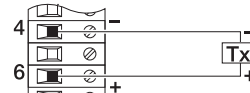

d – 2-wire Transmitter

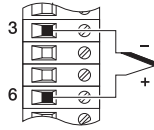

e – Thermocouple

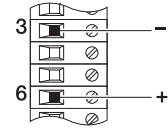

g – Low Voltage (mV)

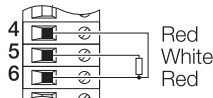

f – 3-wire RTD

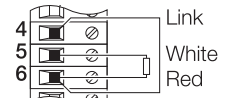

h – 2-wire RTD and Resistance

Standard Input/Output Modules

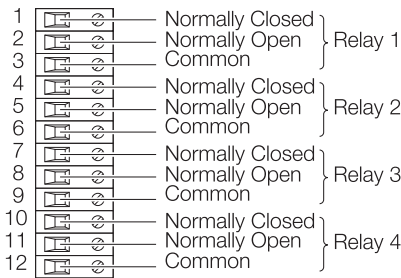

Four-Relay Output Module

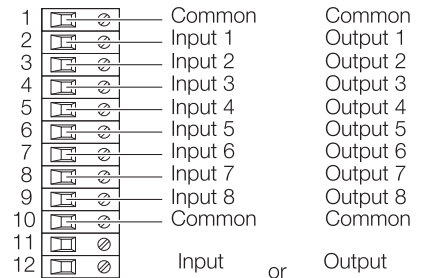

Digital Input/Output Module

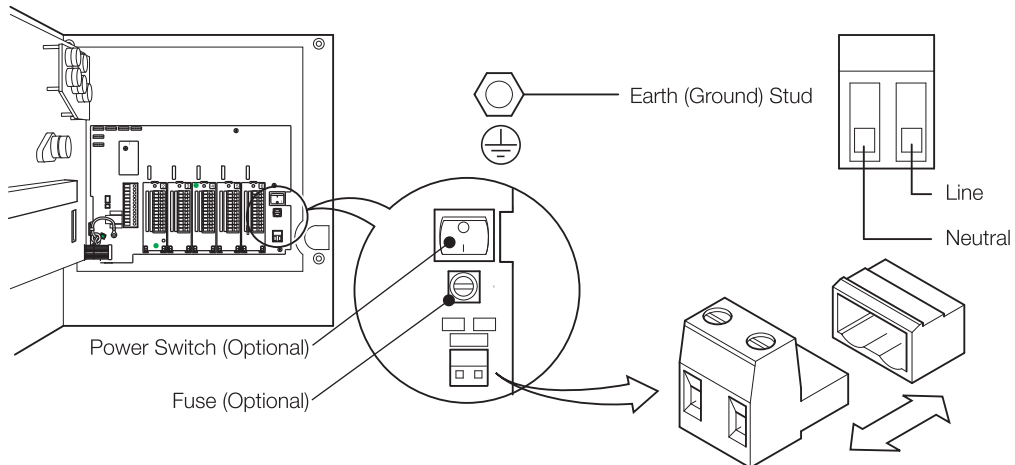

Power Supply Connections

Overall Dimensions

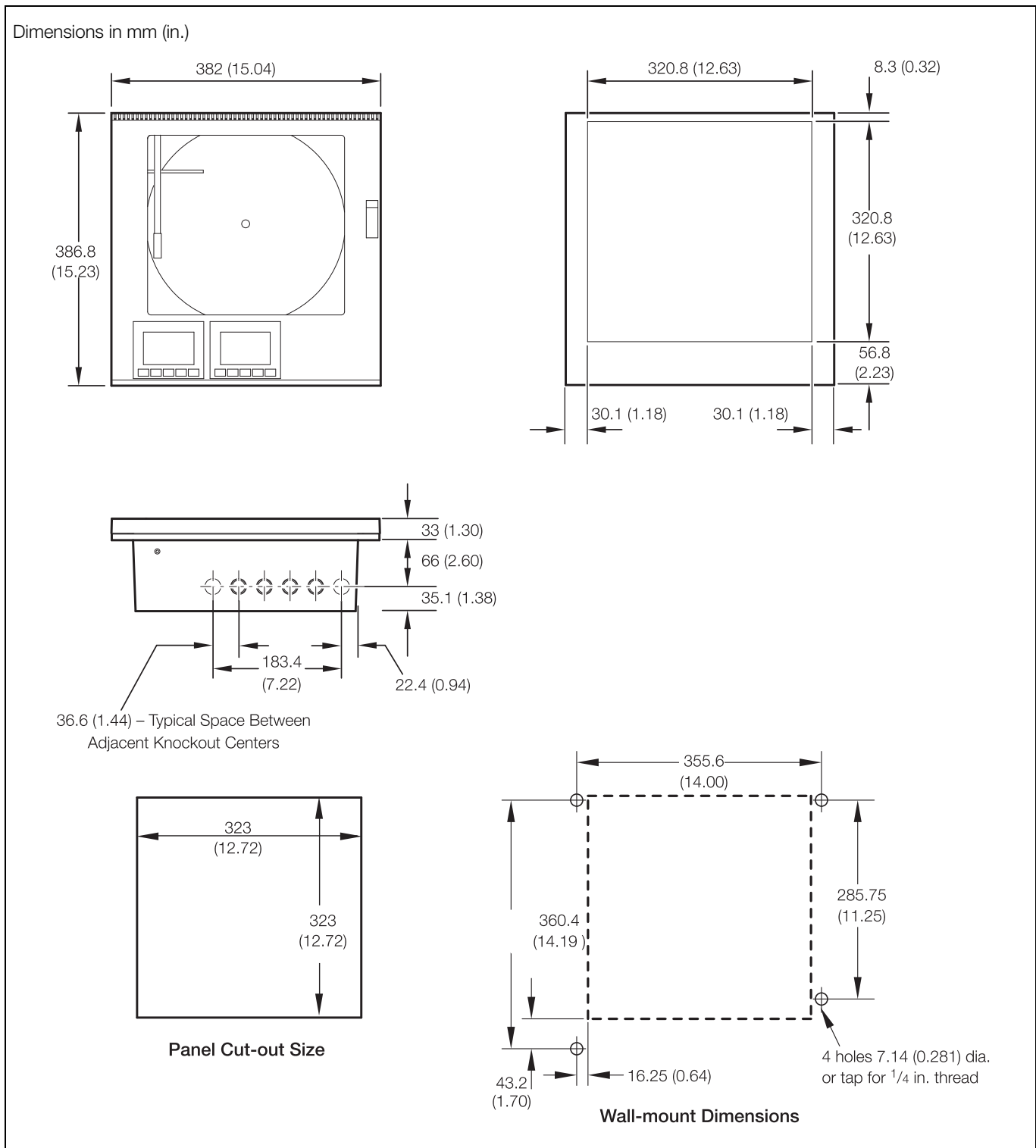

C1300

Advanced Circular Chart Recorder

Ordering Information

C1300 Advanced Circular Chart Recorder	131	X	X	X	X	X	X	X	X	X	X	X	X	X	X	X	XXX
Pens																	
One Pen (Red)	1																
Two Pens (Red, Green)	2																
Three Pens (Red, Green, Blue)	3																
Four Pens (Red, Green, Blue, Black)	4																
Chart Type																	
Standard (ER/C)																	J
KPC 105 PX and PXR type charts																	K
Chessell Brand charts																	C
Electrical Code																	
Standard																	A
CSA approved																	C
UL approved																	U
Software Options																	
None																	0
1 Totalizer, Math & Timers																	1
2 Totalizers, Math & Timers																	2
3 Totalizers, Math & Timers																	3
4 Totalizers, Math & Timers																	4
Environmental Protection																	
IP54 & NEMA3																	0
IP66 & NEMA4X																	N
Door Color																	
ABB standard																	0
Grey																	G
Window Material																	
Glass																	G
Polycarbonate																	P
Door Lock																	
No lock																	0
Lock fitted																	L
Power Supply																	
100 to 240V AC ±10% (90V min. to 264V) max.																	1
100 to 240V AC ±10% (90V min. to 264V) max. with on/off switch																	2
I/O Modules		Module Type (see page 13)															
Module Position 2/Channel 2 Input*	0 1																
Module Position 3/Channel 3 Input*	0 1																
Module Position 4/Channel 4 Input*	0 1 3 4 5 6																
Module Position 5	0 3 4 5 8																
Module Position 6	0 4 5 8 L																
Special Settings																	
Company standard																	STD
Custom configuration (customer to complete and supply C1300 custom configuration sheet – INF08/030)																	CUS
Special																	SXX
Engineered configuration (customer to supply configuration details required)																	ENG

* On 2, 3 or 4 pen instruments, a standard I/O module is always fitted in the corresponding module position (enter '0' in the corresponding order code field)

C1300

Advanced Circular Chart Recorder

Standard Accessories (supplied with each recorder)

Set of pens

Pack of 10 charts (0 to 100, 24 hour)

Wall-mount kit

Optional Accessories

Part No.	Description
C100/0051	PC configuration backup cable
C1900/1713	Pipe-mount kit
SW/DATMGR	DataManager software
B12028	Card reader
B11867	Compact Flash Card
ENG/REC	After-sales engineered configuration service

C1300

Advanced Circular Chart Recorder

Module Identification

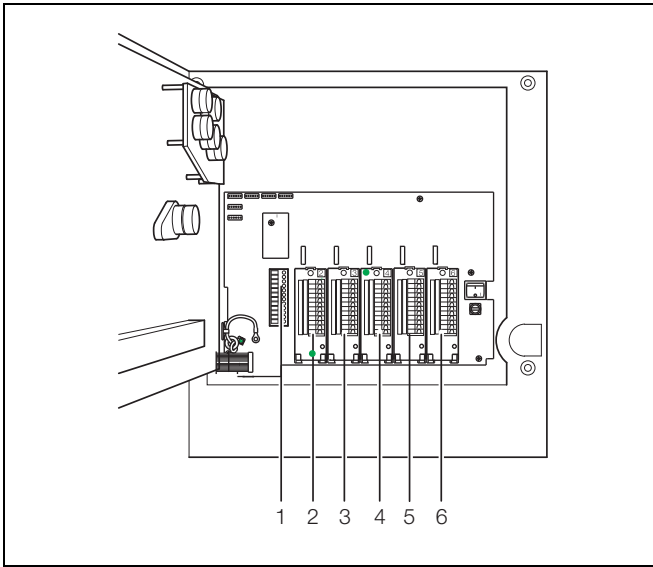

Module Positions

- 0 No module fitted/pen input channel
- 1 Standard input/output
- 3 Four relays
- 4 Eight digital inputs
- 5 Eight digital outputs
- 6 True-time event pen –Violet (additional to standard pens)
- 8 Modbus RS485 communications
- L Data logging

Key to Module Types

Acknowledgements and Trademarks

Modbus™ is a trademark of Modicon, Inc.

Notes

C1300

Advanced Circular Chart Recorder

Contact us

ABB Limited

Process Automation

Howard Road

St. Neots

Cambridgeshire PE19 8EU

UK

Tel: +44 (0)1480 475321

Fax: +44 (0)1480 217948

ABB Inc.

Process Automation

125 E. County Line Road

Warminster

PA 18974

USA

Tel: +1 215 674 6000

Fax: +1 215 674 7183

www.abb.com/recorders

Note

We reserve the right to make technical changes or modify the contents of this document without prior notice. With regard to purchase orders, the agreed particulars shall prevail. ABB does not accept any responsibility whatsoever for potential errors or possible lack of information in this document.

We reserve all rights in this document and in the subject matter and illustrations contained therein. Any reproduction, disclosure to third parties or utilization of its contents in whole or in parts – is forbidden without prior written consent of ABB.

Copyright© 2012 ABB

All rights reserved

3KXR200102R1001



Sales



Service



Software